

Duct/smoke gas temperature measuring transducer, including mounting flange, calibratable, with multi-range switching and active output

Calibratable smoke gas temperature measuring transducer **THERMASGARD® RGTM 1** with eight switchable measuring ranges and continuous output, with connecting head made from aluminium (optionally with **cable gland** or **M12 connector** according to DIN EN 61076-2-101), spring-mounted measuring insert and straight protective tube, incl. mounting flange.

The duct sensor is used to detect high temperatures in gaseous media, eg. for exhaust air or smoke gas temperature measurement.

The sensor is factory-calibrated; an environmental precision adjustment by an expert is possible.

RGTM 1
Basic unit

TECHNICAL DATA

Power supply:	24 V AC / DC (± 10 %) for U variant 15...36 V DC for I variant, depending on working resistance, residual ripple stabilised ± 0.3 V
Working resistance:	$R_a \text{ (Ohm)} = (U_b - 14 \text{ V}) / 0.02 \text{ A}$ for I variant
Load resistance:	$R_L > 5 \text{ kOhm}$ for U variant
Power consumption:	< 1.0 VA / 24 V AC / DC; < 0.55 VA / 24 V DC
Sensor:	Pt1000 (according to DIN EN 60751, class B) (Perfect Sensor Protection)
Measuring ranges:	multi-range switching with 8 switchable measuring ranges, see table (other ranges optional) with manual zero point correction (± 10K)
Accuracy, temperature:	typically ± 0.2 K at +25 °C
Output:	0 - 10 V or 4...20 mA
Connection type:	2- or 3-wire connection
Electrical connection:	0.2 - 1.5 mm ² , via push-in terminal
Cable connection:	RGTM 1 (Standard) adjusting screw made of metal (M20 x 1.5); RGTM 1-KV (optional) cable gland, brass, nickel-plated (M20 x 1.5; with strain relief, exchangeable, inner diameter 6 - 12 mm) RGTM 1-Q (optional) M12 connector according to DIN EN 61076-2-101 (male, 5-pin, A-code)
Dimensions:	see dimensional drawing
Connecting head:	form B, material aluminium, colour white aluminium (similar to RAL 9006), ambient temperature -30...+70 °C
Protective tube:	stainless steel, V4A (1.4571), Ø = 8 mm inserted length (EL) = 200 - 400 mm (see table)
Process connection:	by mounting flange stainless steel V2A (1.4305) (included in the scope of delivery)
Humidity:	< 95 % RH, non-precipitating air
Protection class:	III (according to EN 60 730)
Protection type:	IP 54 (according to EN 60 529) RGTM 1 IP 65 (according to EN 60 529) RGTM 1-KV / RGTM 1-Q
Standards:	CE conformity according to EMC directive 2014 / 30 / EU



RGTM 1
Measuring insert with ceramic tubelet



S+S REGELTECHNIK

THERMASGARD® RGTM 1

Duct/smoke gas temperature measuring transducer, including mounting flange, calibratable, with multi-range switching and active output



Dimensional drawing [mm]

RGTM 1

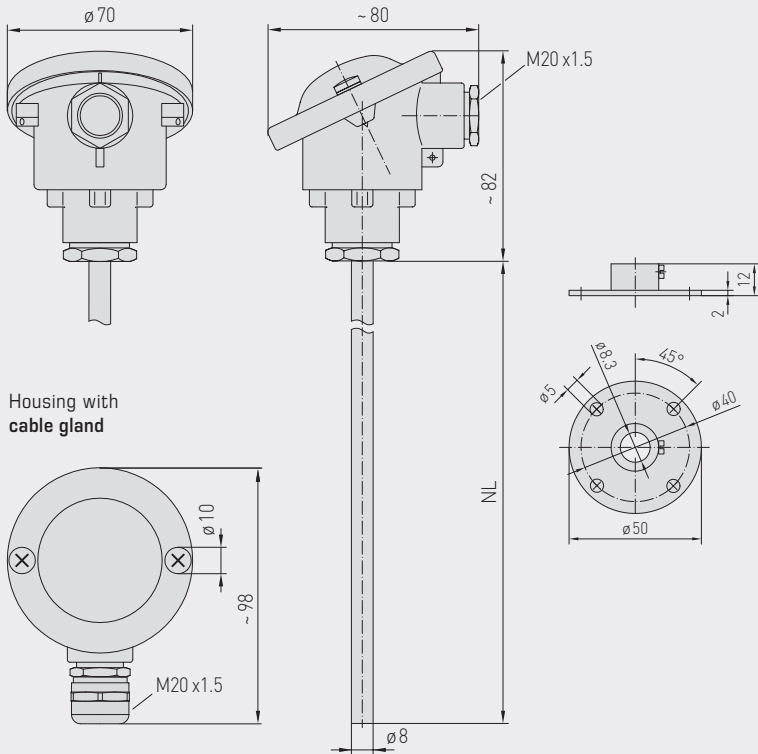

Housing with cable gland

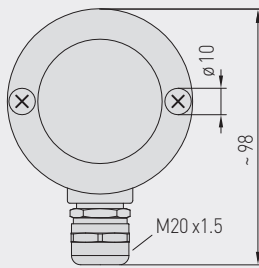

Housing with M12 connector

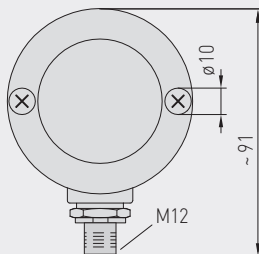

M12 connector (male)

RGTM 1 standard (IP 54)



RGTM 1-KV with cable gland (IP 65)



RGTM 1-Q with M12 connector (IP 65)



High-performance encapsulation against vibration, mechanical stress and humidity

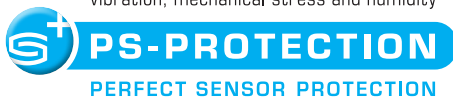

Duct/smoke gas temperature measuring transducer, including mounting flange, calibratable, with multi-range switching and active output

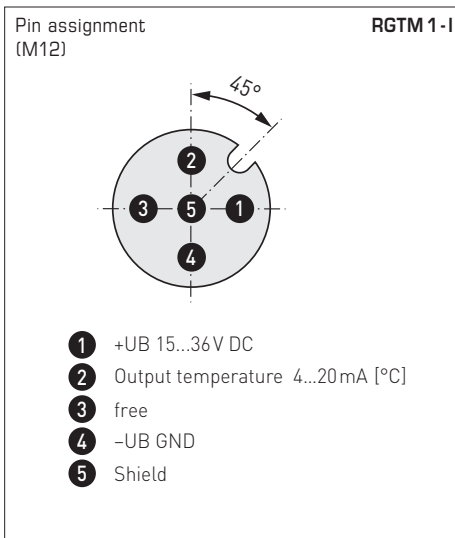
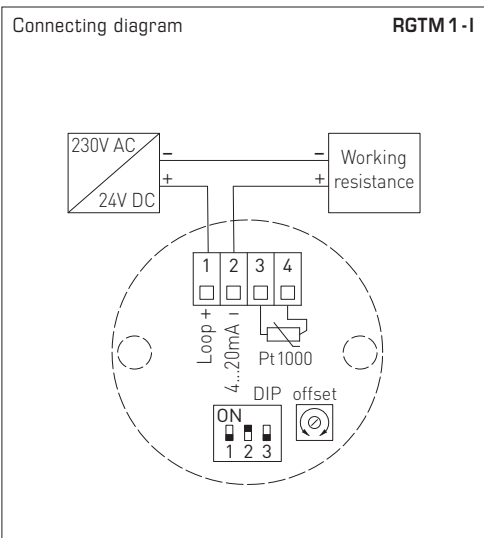
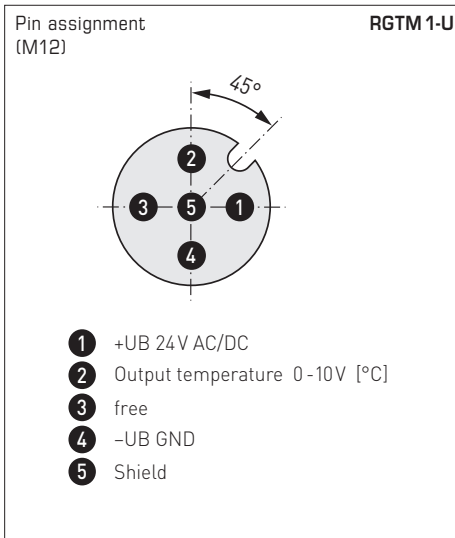
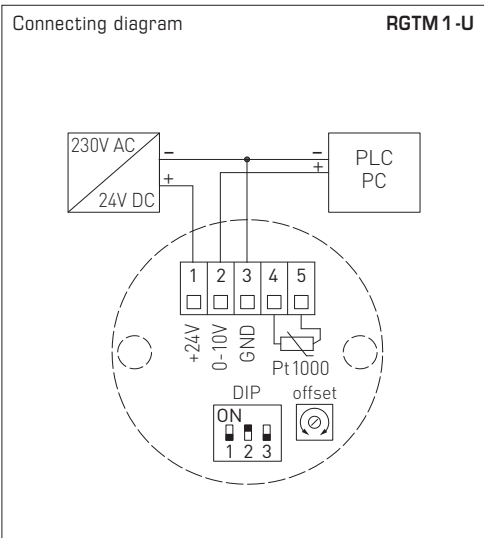

Measuring ranges (adjustable)	DIP 1	DIP 2	DIP 3
-20...+150 °C	ON	ON	ON
0...+50 °C (default)	OFF	ON	ON
0...+100 °C	ON	OFF	ON
0...+200 °C	OFF	OFF	ON
0...+300 °C	ON	ON	OFF
0...+400 °C	OFF	ON	OFF
0...+500 °C	ON	OFF	OFF
0...+600 °C	OFF	OFF	OFF



S+S REGELTECHNIK

THERMASGARD® RGTM 1

Duct/smoke gas temperature measuring transducer,
including mounting flange, calibratable, with multi-range switching
and active output

RGTM 1
standard
(IP 54)



THERMASGARD® RGTM 1		Duct / smoke gas temperature sensor, incl. mounting flange (standard)		
Type / WG01	Output	Installation length (EL)	Item No.	Price
RGTM 1 - I			IP 54, I - variant	
RGTM1-I 200mm	4...20 mA	200 mm	1101-3122-0049-810	308,87 €
RGTM1-I 250mm	4...20 mA	250 mm	1101-3122-0059-810	321,14 €
RGTM1-I 300mm	4...20 mA	300 mm	1101-3122-0069-810	324,55 €
RGTM1-I 400mm	4...20 mA	400 mm	1101-3122-0089-810	327,28 €
RGTM 1 - U			IP 54, U - variant	
RGTM1-U 200mm	0-10 V	200 mm	1101-3121-0049-810	308,87 €
RGTM1-U 250mm	0-10 V	250 mm	1101-3121-0059-810	321,14 €
RGTM1-U 300mm	0-10 V	300 mm	1101-3121-0069-810	324,55 €
RGTM1-U 400mm	0-10 V	400 mm	1101-3121-0089-810	327,28 €
Housing variant:	equipped as standard with pressure screw (IP 54), optional housing variants with cable gland (IP 65) or M12 connector (IP 65) see the next page!			
Extra charge:	other measuring ranges optional			26,16 €

Duct/smoke gas temperature measuring transducer, including mounting flange, calibratable, with multi-range switching and active output

RGTM 1 - Q
with M12 connector (IP65)



THERMASGARD® RGTM 1 - Q		Duct / smoke gas temperature sensor, incl. mounting flange (with M12 connector)				
Type / WG01	Output	Installation length (EL)	Q	Item No.	Price	
RGTM 1 - I xx Q			●	IP 65, I - variant		
RGTM1-I 200mm Q	4...20 mA	200 mm	●	2001-4131-2100-011	353,78 €	
RGTM1-I 250mm Q	4...20 mA	250 mm	●	2001-4131-2100-021	366,06 €	
RGTM1-I 300mm Q	4...20 mA	300 mm	●	2001-4131-2100-031	369,45 €	
RGTM1-I 400mm Q	4...20 mA	400 mm	●	2001-4131-2100-041	372,20 €	
RGTM 1 - U xx Q			●	IP 54, U - variant		
RGTM1-U 200mm Q	0 - 10 V	200 mm	●	2001-4131-1100-011	353,78 €	
RGTM1-U 250mm Q	0 - 10 V	250 mm	●	2001-4131-1100-021	366,06 €	
RGTM1-U 300mm Q	0 - 10 V	300 mm	●	2001-4131-1100-031	369,45 €	
RGTM1-U 400mm Q	0 - 10 V	400 mm	●	2001-4131-1100-041	372,20 €	
Housing variant "Q":		Cable connection with M12 connector (male, 5-pin, A-code)				
Extra charge:	other measuring ranges optional				26,16 €	

ACCESSORIES

Special accessories for M12 connector
see chapter Accessories!



S+S REGELTECHNIK

THERMASGARD® RGTM 1

Duct / smoke gas temperature measuring transducer,
including mounting flange, calibratable, with multi-range switching
and active output

RGTM 1 - KV
with cable gland
(IP 65)



THERMASGARD® RGTM 1 - KV		Duct / smoke gas temperature sensor, incl. mounting flange (with cable gland)		
Type / WG01	Output	Installation length (EL)	Item No.	Price
RGTM 1 - I xx KV		IP 65, I - variant		
RGTM1-I 200mm KV	4...20 mA	200 mm	1101-31D2-0049-810	318,98 €
RGTM1-I 250mm KV	4...20 mA	250 mm	1101-31D2-0059-810	331,27 €
RGTM1-I 300mm KV	4...20 mA	300 mm	1101-31D2-0069-810	334,66 €
RGTM1-I 400mm KV	4...20 mA	400 mm	1101-31D2-0089-810	337,40 €
RGTM 1 - U xx KV		IP 65, U - variant		
RGTM1-U 200mm KV	0 - 10 V	200 mm	1101-31D1-0049-810	318,98 €
RGTM1-U 250mm KV	0 - 10 V	250 mm	1101-31D1-0059-810	331,27 €
RGTM1-U 300mm KV	0 - 10 V	300 mm	1101-31D1-0069-810	334,66 €
RGTM1-U 400mm KV	0 - 10 V	400 mm	1101-31D1-0089-810	337,40 €
Housing variant "KV":		Cable connection with cable gland		
Extra charge:	other measuring ranges optional			26,16 €